

### FEATURES

- $\pm 20$  mV ( $\pm 0.3\%$ ) max. initial tolerance (A grade)
- Operating Current  $20\mu\text{A}$  to  $20\text{mA}$
- Low Voltage Reference  $2.5\text{V}$
- Max.  $0.6\Omega$  Dynamic Impedance (A grade)
- Low Temperature Coefficient
- $1.2\text{V}$  Device also available, AMS1004-1.2

### APPLICATIONS

- Battery Powered Systems
- Instrumentation
- A/D, D/A Converters
- Temperature measurement
- Current sources
- Notebook/Personal Computer
- Monitors/ VCR/ TV
- Pagers

### GENERAL DESCRIPTION

The AMS1004-2.5 is a two-terminal micropower band-gap voltage reference diode. It features a very low dynamic impedance and good temperature coefficient, operating over a  $20\mu\text{A}$  to  $20\text{mA}$  current range. On-chip trimming is used to provide tight voltage tolerance. Since the AMS1004-2.5 is a band-gap reference, uses only transistors and resistors, low noise and good long term stability result. Careful design of the AMS1004-2.5 has made the device exceptionally tolerant of capacitive loading, making it easy to use in almost any reference application. The wide dynamic operating range allows its use with widely varying supplies with excellent regulation. The extremely low power drain of the AMS1004-2.5 makes these reference diodes useful for micropower circuitry. This voltage reference can be used to make portable meters, regulators or general purpose analog circuitry with battery life approaching shelf life.

Further more, the wide operating current allows it to replace older references with a tight tolerance part, making it attractive for use in systems where accuracy was previously obtained at the expense of power consumption and trimming.

The AMS1004-2.5 is operational over a temperature range of  $0^\circ\text{C}$  to  $70^\circ\text{C}$  and is available in TO-92, SO-8 and SOT-89 packages. For extended temperature range contact factory.

### ORDERING INFORMATION:

TOL.	PACKAGE TYPE			OPERATING TEMPERATURE RANGE
	TO-92	8 LEAD SOIC	SOT-89	
$\pm 20\text{mV}$	AMS1004-2.5AN	AMS1004-2.5AS	AMS1004-2.5AL	0 to $70^\circ\text{C}$
$\pm 40\text{mV}$	AMS1004-2.5BN	AMS1004-2.5BS	AMS1004-2.5BL	0 to $70^\circ\text{C}$

## ABSOLUTE MAXIMUM RATINGS

Reverse Current	30mA	Storage temperature	-55°C to +150°C
Forward Current	10mA	Soldering information	
Operating Temperature Range	0°C to 70°C	TO-92 package: 10 sec.	260°C
		SOIC package: Vapor phase (60 sec)	215°C
		Infrared (15 sec.)	220°C
		SOT-89 package: 10 sec.	265°C

## ELECTRICAL CHARACTERISTICS

Electrical Characteristics at  $I_R = 100 \mu A$ , and  $T_A = +25^\circ C$  unless otherwise specified.

Parameter	Conditions	AMS1004A-2.5			AMS1004B-2.5			Units
		Min	Typ	Max	Min	Typ	Max	
Reverse Breakdown Voltage (Note 4)	$I_R - 100 \mu A$	2.480	2.500	2.520	2.460	2.500	2.540	V
Reverse Dynamic Impedance (Note 4)	$I_R - 100 \mu A, f = 20\text{Hz}$		0.2	0.60		0.2	0.60	$\Omega$
Reverse Breakdown Voltage Change with current (Note 4)	$10\mu A \leq I_R \leq 1\text{mA}$ $1\text{mA} \leq I_R \leq 20\text{mA}$		1.0 10				1.0 10	mV
Min. Operating Current (Note 4)			12	10 <b>20</b>		12	10 <b>20</b>	$\mu A$ $\mu A$
Wide Band Noise (Note 5)	$I_R - 100 \mu A,$ $10\text{Hz} \leq f \leq 10\text{kHz}$		120			120		$\mu V$
Temperature Coeff. (Note 6)			<b>25</b>			<b>50</b>		ppm/°C
Long Term Stability (Note 5)	$T_A = 25^\circ C \pm 1^\circ C$ $T = 1000 \text{ Hr}$		20			20		ppm

**Note 1:** Absolute Maximum Ratings indicate limits beyond which damage to the device may occur. Operating Ratings indicate conditions for which the device is intended to be functional, but do not guarantee specific performance limits. For guaranteed specifications and test conditions, see the Electrical Characteristics. The guaranteed specifications apply only for the test conditions listed.

**Note 2:** For elevated temperature operation,  $T_j$  max is  $+100^\circ C$

Thermal Resistance	TO-92	SO-8	SOT-89
$\theta_{JA}$ (junction to ambient)	170°C/W (0.125" leads)	165°C/W	160°C/W

**Note 3:** Parameters identified with **boldface type** apply at temperature extremes. All other numbers apply at  $T_A = T_j = 25^\circ C$ .

**Note 4:** Guaranteed and 100% production tested.

**Note 5:** Guaranteed but not 100% production tested. These limits are not used to calculate average outgoing quality levels.

**Note 6:** The average temperature coefficient is defined as the maximum deviation of reference voltage at all measured temperatures between the operating  $T_{MAX}$  and  $T_{MIN}$ , divided by  $T_{MAX} - T_{MIN}$ . The measured temperatures are  $0^\circ C, 25^\circ C, 70^\circ C$ .

## PIN CONNECTIONS

**TO-92**  
Plastic Package (N)

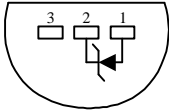

Bottom View

**SO-8**  
SO Package (S)

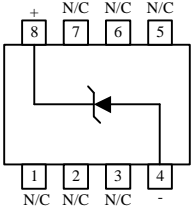

Top View

**SOT-89**  
(L)

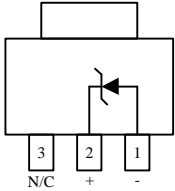

Top View

## TYPICAL APPLICATIONS

**Wide Input Range Reference**

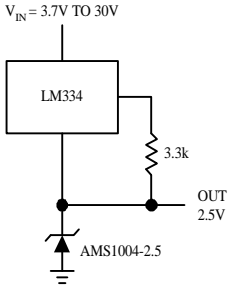

**Micropower Reference from 9V Battery**

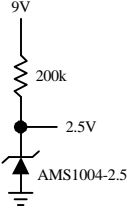

**Micropower Thermocouple Cold Junction Compensator**

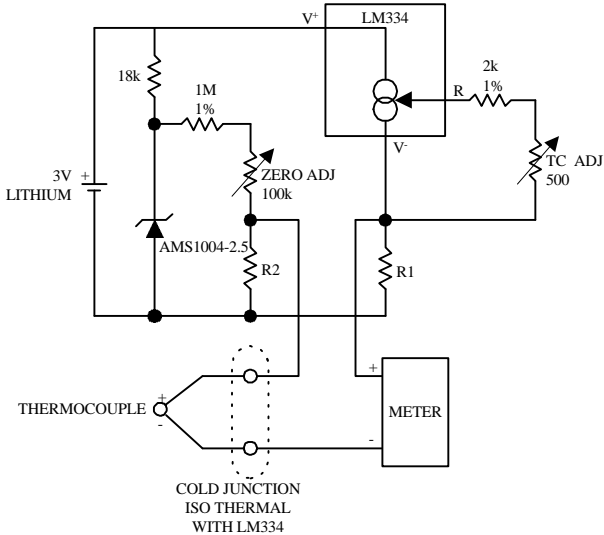

**Adjustment Procedure**

1. Adjust TC ADJ pot until voltage across R1 equals Kelvin temperature multiplied by the thermocouple Seebeck coefficient.
2. Adjust ZERO ADJ pot until voltage across R2 equals the thermocouple Seebeck coefficient multiplied by 273.2.

Thermocouple Type	Seebeck Coefficient (mV/ °C)	R1 (Ω)	R2 (Ω)	Voltage Across R1 @ 25°C (mV)	Voltage Across R2 (mV)
J	52.3	523	1.24k	15.60	14.32
T	42.8	432	1k	12.77	11.78
K	40.8	412	953Ω	12.17	11.17
S	6.4	63.4	150Ω	1.908	1.766

Typical supply current 50µA



## TYPICAL PERFORMANCE CHARACTERISTICS

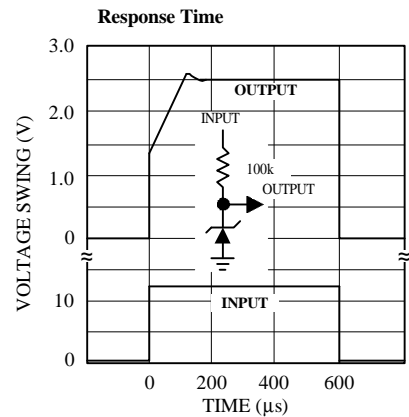
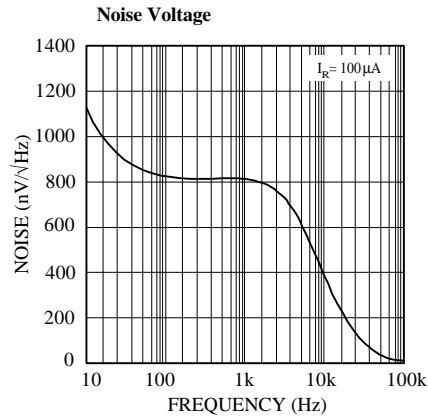
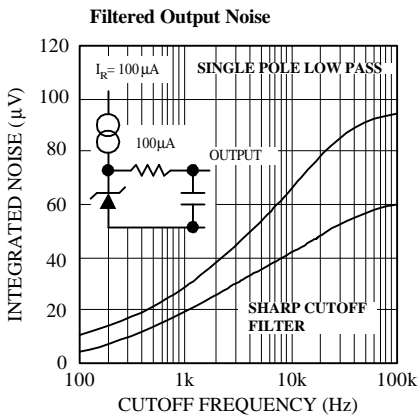
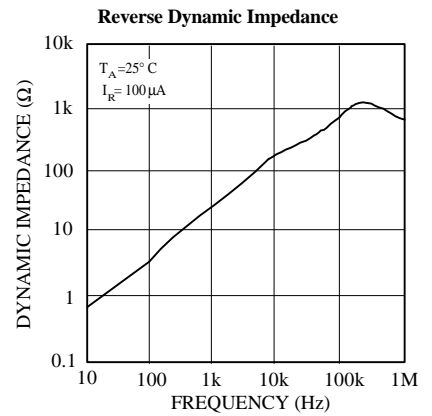
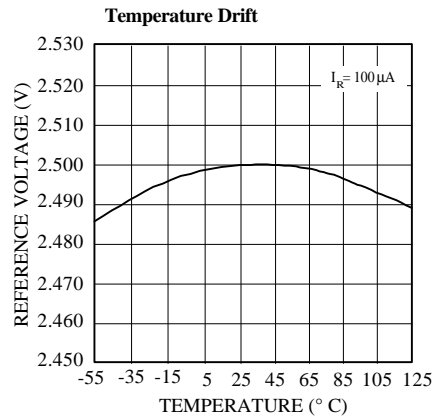
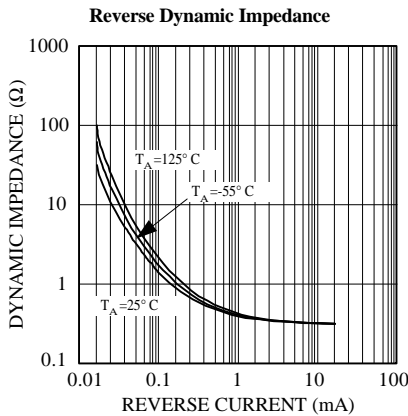
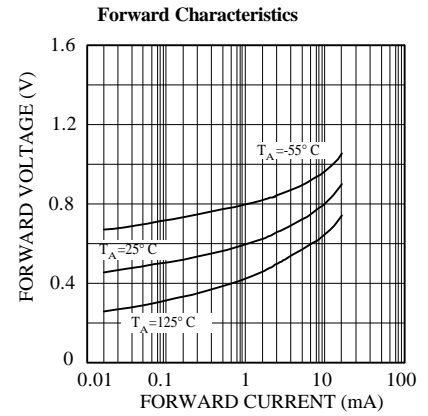
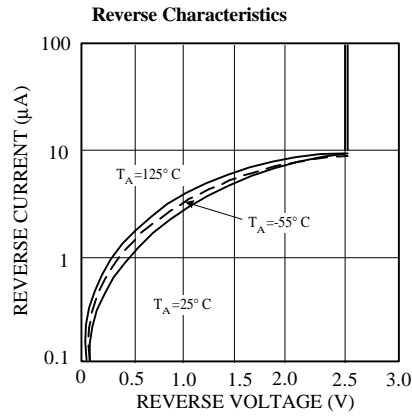
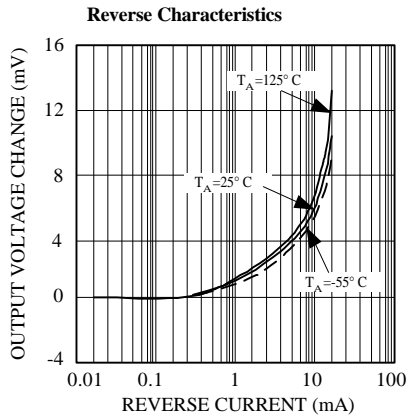



PACKAGE DIMENSIONS inches (millimeters) unless otherwise noted (Continued).

## SOT-89 PLASTIC PACKAGE (L)

